

# fantasia 2



POZZI-GINORI

## Sanitec

Pozzi-Ginori fa parte di Sanitec, un gruppo europeo multimarca che progetta, produce e distribuisce ceramiche da bagno e prodotti bath and shower.

Il Gruppo riunisce marchi molto conosciuti a livello locale, che hanno una posizione forte e radici profonde nel settore bagno, ed è uno dei leader europei nella fornitura di soluzioni per il bagno.

Sanitec conta circa 7.500 dipendenti, la maggior parte dei quali in Europa.

I 19 stabilimenti produttivi sono dislocati sul territorio europeo, mentre la rete vendite e marketing opera a livello mondiale.

Pozzi-Ginori is a part of Sanitec, a European multi-brand group that designs, manufactures and markets bathroom ceramics and bath and shower products.

The Group is based on locally well known brands, which have strong positions and deep roots in the bathroom business, and is well positioned as a leading European provider for bathroom solutions.

The Group employs around 7.500 people, mainly in Europe.

The 19 production plants are located in Europe whereas the sales and marketing network operates world-wide.





# fantasia 2

forme naturali, linee morbide ma decise, per soluzioni d'arredo semplicemente originali, pratiche ed eleganti.

fantasia 2 è la collezione rinnovata di pozzi-ginori che propone un ambiente bagno confortevole, da vivere con stile, giorno per giorno.

un mix di ingredienti che compongono con gusto la privacy domestica: dai lavabi di diverse misure, anche in versione asimmetrica, ai sanitari con modelli a terra e sospesi. per vivere lo spazio come più piace.

natural forms and soft, yet definite lines, for furnishing solutions that are simply original, practical and elegant.

fantasia 2 is the up-dated collection from pozzi-ginori that offers a comfortable bathroom environment to be enjoyed in style, day after day.

a mix of ingredients that tastefully arrange domestic privacy: from washbasins in various sizes, also in asymmetric versions, to sanitary fittings with floor-standing and wall-mounted models. to experience the bathroom just how you want it.

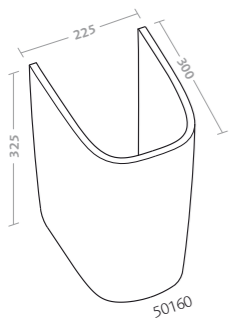
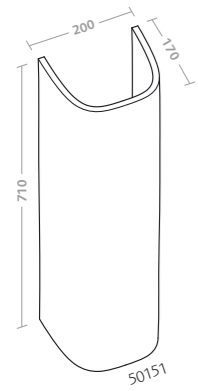
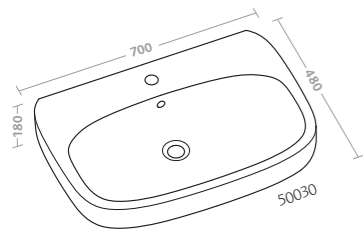
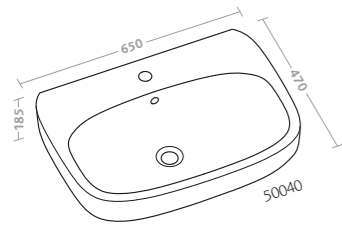
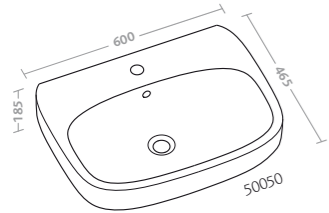
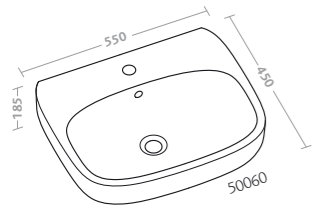
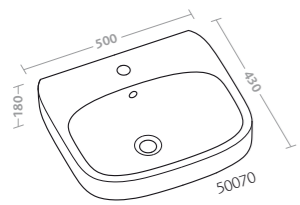

lavabo 60 (50050)  
pagina precedente  
lavabo 60 (50050)

washbasin 60 (50050)  
previous page  
washbasin 60 (50050)





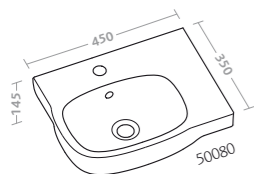
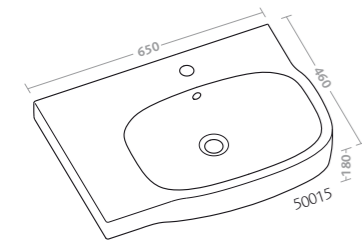
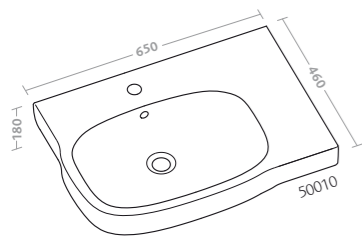

specchio orizzontale 120x40 della serie "complementi d'arredo" (41833)  
lavabo asimmetrico 65 destro (50010)  
lavabo asimmetrico 65 sinistro (50015)  
pagine precedenti  
specchio verticale 40x90 della serie "complementi d'arredo" (41832)  
lavabo 60 (50050)  
colonna (50151)  
vasca Kalima 170x70 di ALBATROS

horizontal mirror 120x40 of the "complementi d'arredo" series (41833)  
asymmetrical washbasin 65 right (50010)  
asymmetrical washbasin 65 left (50015)  
previous pages  
vertical mirror 40x90 of the "complementi d'arredo" series (41832)  
washbasin 60 (50050)  
pedestal (50151)  
tub Kalima170x70 by ALBATROS









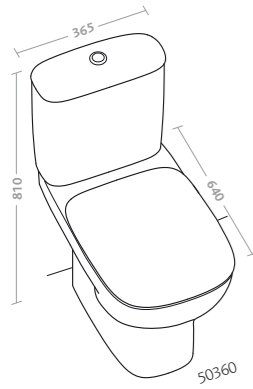
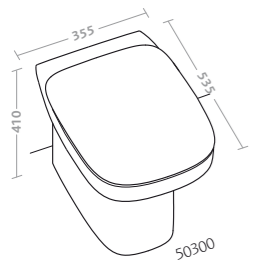
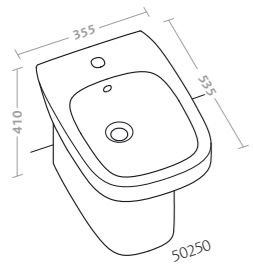
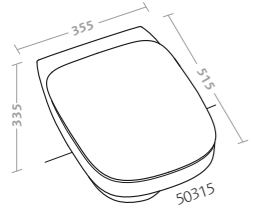
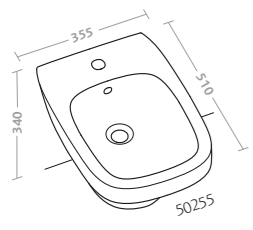

bidet sospeso (50255)  
vaso sospeso (50315)  
pagine precedenti  
specchio orizzontale 120x40 della  
serie "complementi d'arredo"  
(41833)  
bidet sospeso (50255)  
vaso sospeso (50315)  
lavabo asimmetrico 65 destro  
(50010)  
lavabo asimmetrico 65 sinistro  
(50015)  
contenitore orizzontale con anta  
120x30 della serie "complementi  
d'arredo" (41874)  
pagine successive  
bidet (50250)  
vaso (50300)  
box doccia KeyBox R97  
di ALBATROS

wall hung bidet (50255)  
wall hung water closet (50315)  
previous pages  
horizontal mirror 120x40 of the  
"complementi d'arredo" series  
(41833)  
wall hung bidet (50255)  
wall hung water closet (50315)  
asymmetrical washbasin 65 right  
(50010)  
asymmetrical washbasin 65 left  
(50015)  
horizontal cabinet with door  
120x30 of the "complementi  
d'arredo" series (41874)  
following pages  
bidet (50250)  
water closet (50300)  
shower box KeyBox R97  
by ALBATROS







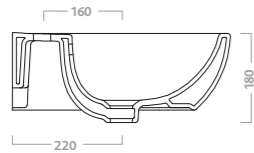
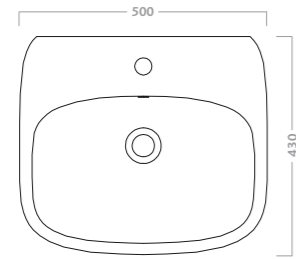

**lavabo 50**

disponibile per rubinetteria monoforo e a tre fori (foro centrale aperto e due fori a frattura prestabilita). peso kg ca. 13

codice	descrizione
50070	lavabo 50

**washbasin 50**

available with one or three tap-holes (central tap-hole fully punched, other two tap-holes semi-punched). approx. weight 13 kg

code	description
50070	washbasin 50

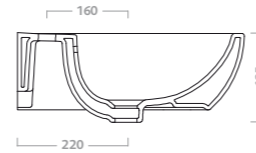
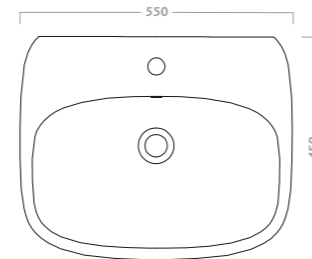
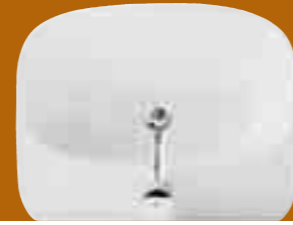

**lavabo 55**

disponibile per rubinetteria monoforo e a tre fori (foro centrale aperto e due fori a frattura prestabilita). peso kg ca. 14

codice	descrizione
50060	lavabo 55

**washbasin 55**

available with one or three tap-holes (central tap-hole fully punched, other two tap-holes semi-punched). approx. weight 14 kg

code	description
50060	washbasin 55

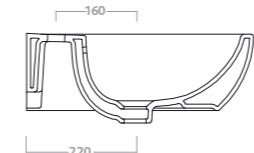
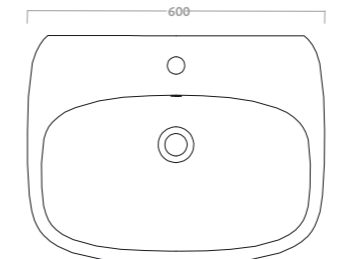

**lavabo 60**

disponibile per rubinetteria monoforo e a tre fori (foro centrale aperto e due fori a frattura prestabilita). peso kg ca. 14,5

codice	descrizione
50050	lavabo 60

**washbasin 60**

available with one or three tap-holes (central tap-hole fully punched, other two tap-holes semi-punched). approx. weight 14,5 kg

code	description
50050	washbasin 60

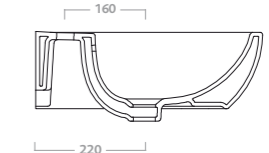
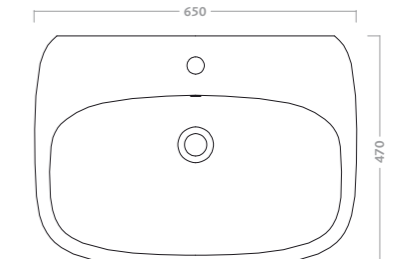
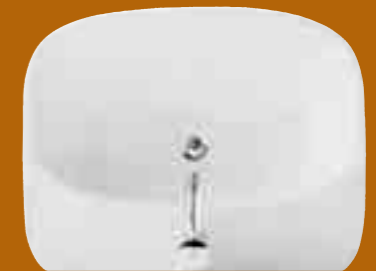

**lavabo 65**

disponibile per rubinetteria monoforo e a tre fori (foro centrale aperto e due fori a frattura prestabilita). peso kg ca. 15,2

codice	descrizione
50040	lavabo 65

**washbasin 65**

available with one or three tap-holes (central tap-hole fully punched, other two tap-holes semi-punched). approx. weight 15,2 kg

code	description
50040	washbasin 65



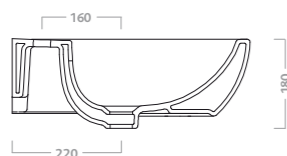
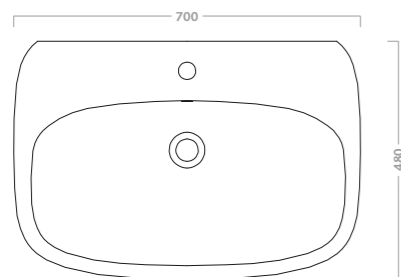

**lavabo 70**

disponibile per rubinetteria monoforo e a tre fori (foro centrale aperto e due fori a frattura prestabilita). peso kg ca. 19

codice	descrizione
50030	lavabo 70

**washbasin 70**

available with one or three tap-holes (central tap-hole fully punched, other two tap-holes semi-punched). approx. weight 19 kg

code	description
50030	washbasin 70

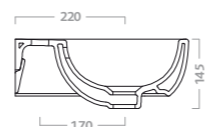
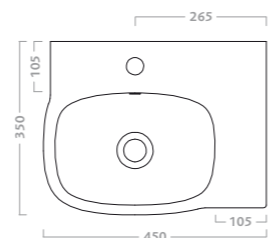

**lavamani 45**

disponibile per rubinetteria monoforo (foro centrale aperto). peso kg ca. 8,6

codice	descrizione
50080	lavamani 45

**hand washbasin 45**

available with one tap-hole (central tap-hole fully punched). approx. weight 8,6 kg

code	description
50080	hand washbasin 45

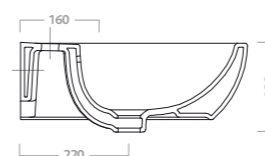
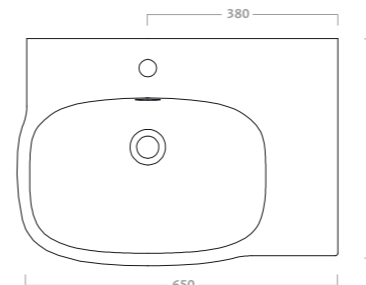

**lavabo asimmetrico 65 destro**

disponibile per rubinetteria monoforo e a tre fori (foro centrale aperto e due fori a frattura prestabilita). peso kg ca. 16,8

codice	descrizione
50010	lavabo asimmetrico 65 dx

**asymmetrical washbasin 65 right**

available with one or three tap-holes (central tap-hole fully punched, other two tap-holes semi-punched). approx. weight 16,8 kg

code	description
50010	asymmetrical washbasin 65 r

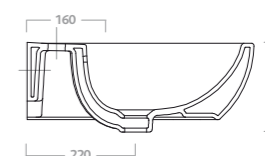
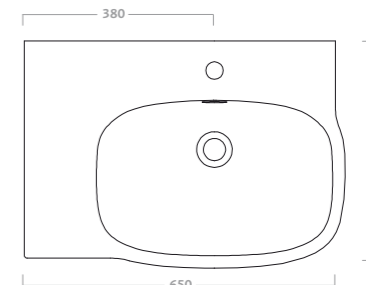

**lavabo asimmetrico 65 sinistro**

disponibile per rubinetteria monoforo e a tre fori (foro centrale aperto e due fori a frattura prestabilita). peso kg ca. 16,8

codice	descrizione
50015	lavabo asimmetrico 65 sx

**asymmetrical washbasin 65 left**

available with one or three tap-holes (central tap-hole fully punched, other two tap-holes semi-punched). approx. weight 16,8 kg

code	description
50015	asymmetrical washbasin 65 l



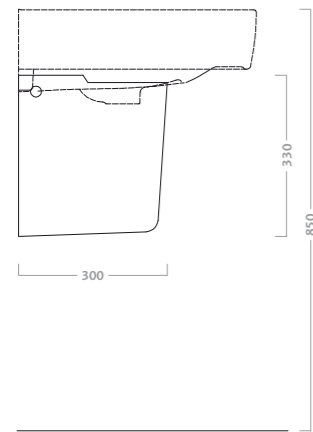

**semicolonna**

da abbinare a lavabi 50 cod. 50070, 55 cod. 50060, 60 cod. 50050, 65 cod. 50040, 70 cod. 50030.

peso kg ca. 8,2

codice	descrizione
50160	semicolonna

**semi-pedestal**

to be combined to washbasins 50 cod. 50070, 55 cod. 50060, 60 cod. 50050, 65 cod. 50040, 70 cod. 50030.

approx. weight 8,2 kg

code	description
50160	semi-pedestal

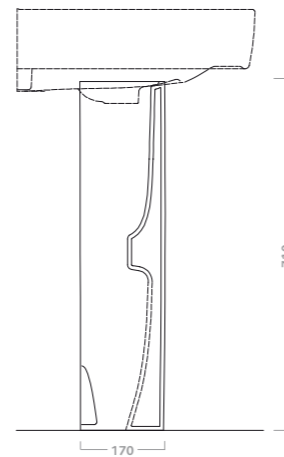

**colonna**

da abbinare a lavabi 50 cod. 50070, 55 cod. 50060, 60 cod. 50050, 65 cod. 50040, 70 cod. 50030. peso kg ca. 11

codice	descrizione
50151	colonna

**pedestal**

to be combined to washbasins 50 cod. 50070, 55 cod. 50060, 60 cod. 50050, 65 cod. 50040, 70 cod. 50030.

approx. weight 11 kg

code	description
50151	pedestal

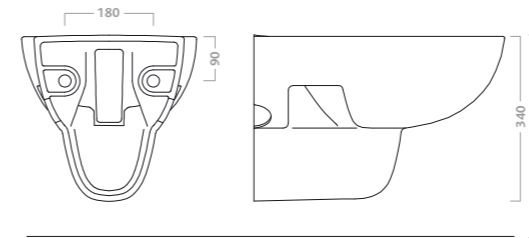
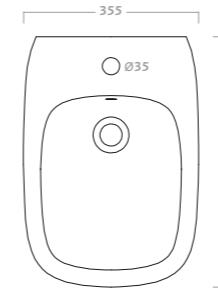

**bidet sospeso**

disponibile per rubinetteria monoforo. peso kg ca. 15,5

codice	descrizione
50255	bidet sospeso
20968	supporto per muro non portante
20961	supporto per muro portante

**wall hung bidet**

available with one tap-hole. approx. weight 15,5 kg

code	description
50255	wall hung bidet
20968	bracket support for non-bearing wall
20961	bracket support for bearing wall

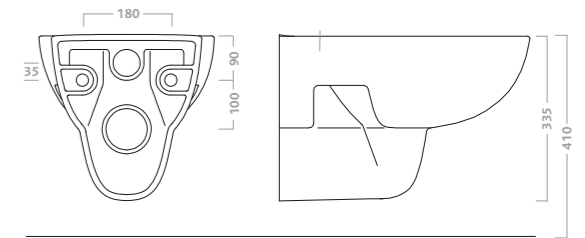
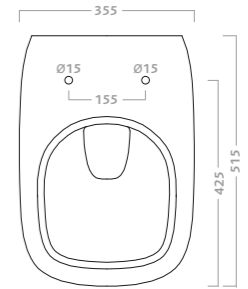

**vaso sospeso**

vaso a cacciata con scarico a parete (p). funziona con 6 litri. peso kg ca. 13,7

codice	descrizione
50315	vaso sospeso
50760	sedile in termoidurente con cerniere cromate
20969	supporto per muro non portante
20961	supporto per muro portante

**wall hung water closet**

horizontal (h) outlet washdown bowl. 6 litres flushing. approx. weight 13,7 kg

code	description
50315	wall hung water closet
50760	duroplast seat with chrome-plated hinges
20969	bracket support for non-bearing wall
20961	bracket support for bearing wall



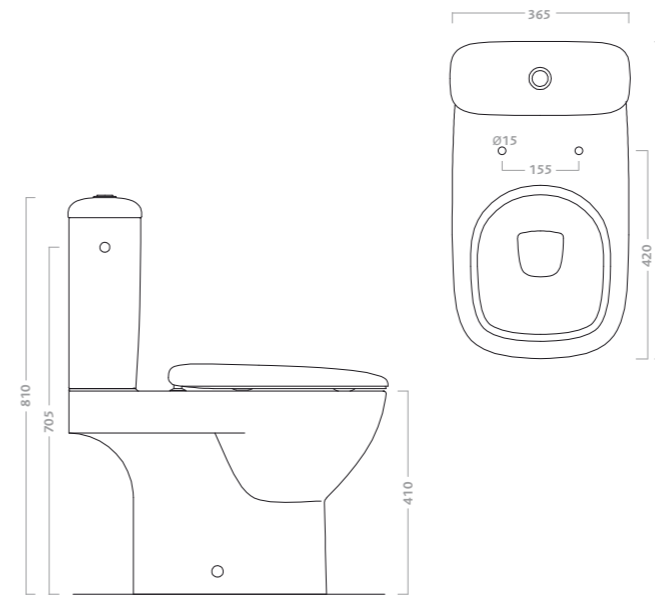
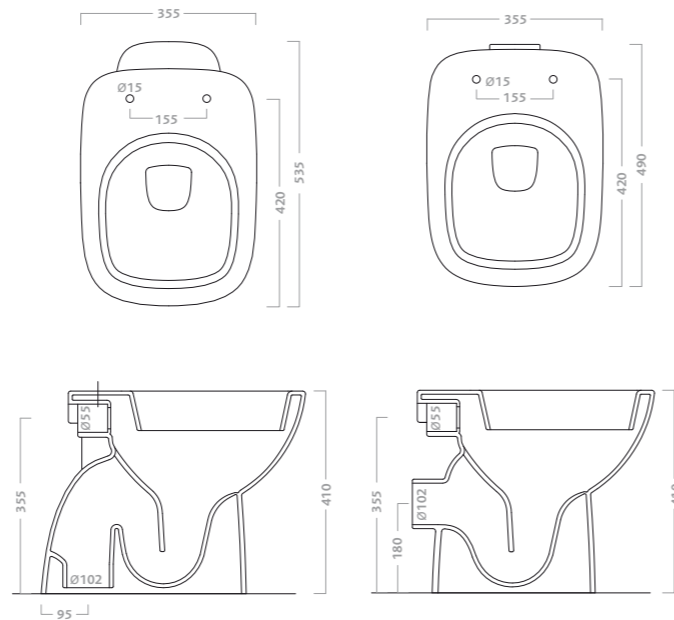
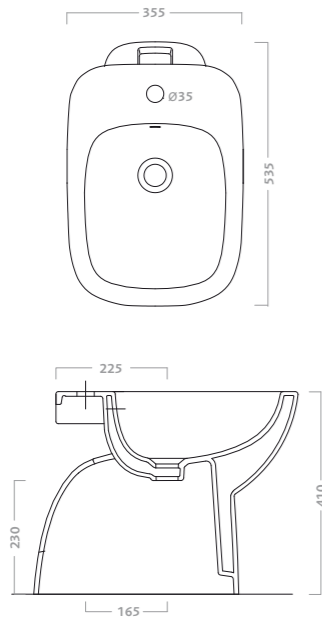

**bidet**

disponibile per rubinetteria monoforo. kit di fissaggio incluso (89962). peso kg ca. 18

codice	descrizione
50250	bidet

**bidet**

available with one tap-hole. fixing kit included (89962). approx. weight 18 kg

code	description
50250	bidet

**vaso**

vaso a cacciata con scarico a pavimento (s) o a parete (p). funziona con 6 litri. kit di fissaggio incluso (89962)

codice	descrizione
50300	vaso con scarico a pavimento (s) peso kg ca. 21
50310	vaso con scarico a parete (p) peso kg ca. 18,5
50760	sedile in termoindurente con cerniere cromate

**water closet**

vertical (v) or horizontal (h) outlet washdown bowl. 6 litres flushing. fixing kit included (89962)

code	description
50300	vertical (v) outlet water closet approx. weight 21 kg
50310	horizontal (h) outlet water closet approx. weight 18,5 kg
50760	duroplast seat with chrome-plated hinges

**vaso per cassetta**

vaso a cacciata con scarico multi (s/p). funziona con 6 litri. kit di fissaggio incluso (89962)

codice	descrizione
50360	vaso per cassetta con scarico multi (s/p) peso kg ca. 24
50470	cassetta A.A./D.S. completa di coperchio e batteria cromata. peso kg ca. 8
50760	sedile in termoindurente con cerniere cromate

**water closet to be combined with cistern**

multi outlet (v/h) washdown bowl. 6 litres flushing. fixing kit included (89962)

code	description
50360	multi outlet (v/h) water closet to be combined with cistern approx. weight 24 kg
50470	high water entry cistern with chrome-plated mechanism. approx. weight 8 kg
50760	duroplast seat with chrome-plated hinges







art direction  
**antonio citterio**  
graphic design  
**limbo**  
concept & styling  
**ravaiolisilenzistudio**  
photo  
**gionata xerra**  
photo assistant  
**pierpaolo mazzola**  
photo retouching  
**danilo pasquali**  
art buying  
**bruno tarsia**

thanks to  
**antonella bondi**  
**grohe rubinetterie**  
**kundalini**  
**riva 1920**  
**segno**



Pozzi-Ginori è storia dell'arte e del design italiani della porcellana da bagno. Le sue origini risalgono al 1735, quando il marchese Carlo Ginori dette inizio, fra i primi in Europa, alla creazione di splendidi manufatti in quel prezioso tipo di ceramica che allora era chiamato "l'oro bianco". La sua Manifattura di Doccia, a nord ovest di Firenze, divenne presto fra le massime d'Europa.

Nel tempo, con la Ginori si fusero le altre manifatture ceramiche progressivamente sorte in Italia: prima quella di Giulio Richard, poi la Società Ceramica Italiana di Laveno, quindi la Pozzi.

Ognuna di queste, prima da sola, poi integrandosi alle altre, ha segnato le varie tappe della sapienza e della tecnologia italiane nella progettazione e nella realizzazione di prodotti sanitari in porcellana. Con l'iniziare e poi l'affermarsi dei metodi e della prassi dell'industrial design, fin dal 1918 grandi designer hanno contribuito a scandire tali tappe: Giò Ponti, Guido Andlovitz, lo studio Nizzoli, Giovanni Gariboldi, Antonia Campi, Gae Aulenti, Paolo Tilche, Matteo Thun, fra i più noti. Ed ora anche Antonio Citterio.

Entrata in Sanitec Group nel 1994, Pozzi-Ginori continua la sua grande tradizione con immutata costante capacità innovativa.

Pozzi-Ginori represents the history of Italian art and design in bathroom ceramics. Its origins date to 1735, when Marquess Carlo Ginori was one of the first people in Europe to begin manufacturing splendid objects in a precious grade of ceramics they used to call "white gold." His Doccia Factory northwest of Florence quickly became one of the largest in Europe.

Over time, Ginori merged with other ceramic manufacturers that progressively sprang up in Italy: first, there was Giulio Richard, then the Laveno Italian Ceramic Company, and finally Pozzi.

Each manufacturer began on its own, then merging with the others, as they established milestones in Italian technology and expertise in the design and creation of bathroom ceramic products. As the methods and practices of industrial design originated and then asserted themselves, great designers have helped articulate various stages since 1918: Giò Ponti, Guido Andlovitz, the Nizzoli studio, Giovanni Gariboldi, Antonia Campi, Gae Aulenti, Paolo Tilche, and Matteo Thun are some of the better known ones. Now there is Antonio Citterio.

After entering the Sanitec Group in 1994, Pozzi-Ginori has continued this grand tradition with its unchanging, constant capacity to innovate

**I dati e le caratteristiche indicate non impegnano Pozzi-Ginori S.p.A. che si riserva il diritto di apportare delle modifiche ritenute opportune senza obbligo di preavviso e sostituzione.**

The data and characteristics indicated in this catalogue do not bind Pozzi-Ginori S.p.A., which reserves the right to make the necessary modifications without notice or product replacement.



Pozzi-Ginori SpA  
via Valcellina, n. A2 z.i. nord  
33097 Spilimbergo PN Italy  
tel. +39 0427 594111  
fax +39 0427 50304  
[www.pozzi-ginori.com](http://www.pozzi-ginori.com)